



## Fixed panel line



Pivoting fly screen, AMERICA is suitable to verandas, patios, conservatories and french-doors.

It is supplied in:

- ✓ Do-it-Yourself Kit one or two shutters;
- ✓ Bars and assembling accessories;
- ✓ Custom-made

### Frames

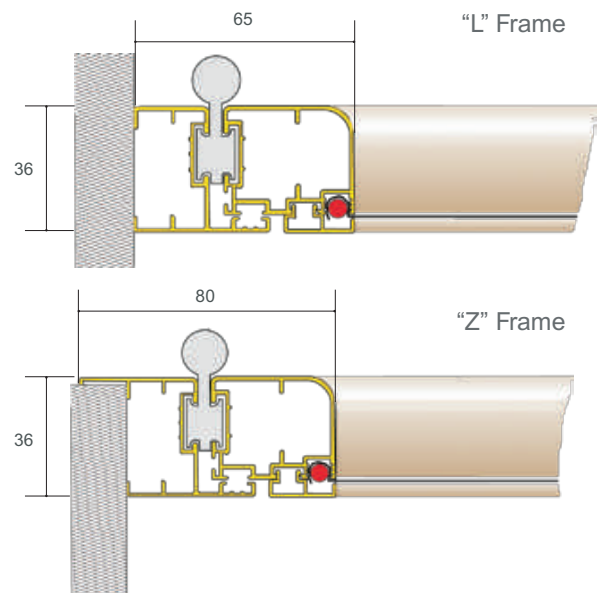

Dimensions must be communicated Width X Height in mm clearly stating if it is finished measure of the flyscreen or if it is the opening measure

- ✓ Finished measure: flyscreen supplied with the given sizes.
- ✓ Window opening: the flyscreen will be supplied 2mm less than the given size

! suggested size (mm)		W	H
1 shutter	min.	-	-
	max.	1000	2600
2 shutters	min.	-	-
	max.	2000	2600

Recovery hinge



Kontakt, tel +48 34 322 34 54



Fixed panel line

profiles and accessories

Frame profile Z

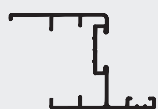

410 gr/lm

Shutter profile



470 gr/lm

Cross profile



460 gr/lm

Covering profile



105 gr/lm

Central profile



180 gr/lm

Price according to the market quotation of aluminium

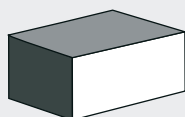

Accessories set for 1 shutter

Box 25 pc  
€ 25,56 pc

Supplement 2 shutters h 50

€ 19,16 pc



Weather strip 6 x 9

Roll 450 lm  
€ 0,49 lm

€ 225,81 rt



Rubber seal Ø 6,5 - Ø 7 mm

Roll 200 lm  
€ 51,11 rt - € 0,29 lm

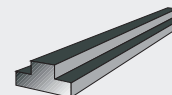

Magnetic strip

Roll 400 lm  
€ 384,00 rt - € 1,01 lm

Do-it yourself kit

Kit doesn't include screening, but rubber seal Ø 6,5 mm for aluminium

Dimensions	W	H	
1 shutter	100	240	€ 191,67
2 shutters	140	240	€ 287,48

custom made

AMERICA

Optional	Assembled with dark aluminium screening	min. to be invoiced: 1 sh. 2 sq.m./ 2 sh. 3 sq.m	€ 127,81 sqm
	Not assembled without screening	min. to be invoiced: 1 sh. 2 sq.m./ 2 sh. 3 sq.m	€ 95,83 sqm
	Recovery hinge		€ 12,37 pc
	Aluminium screen 16/18 *		€ 18,93 sqm
	Petscreen standard grey		€ 15,25 sqm

Kontakt, tel +48 34 322 34 54

VERSION TO BE SPECIFIED IN THE ORDER

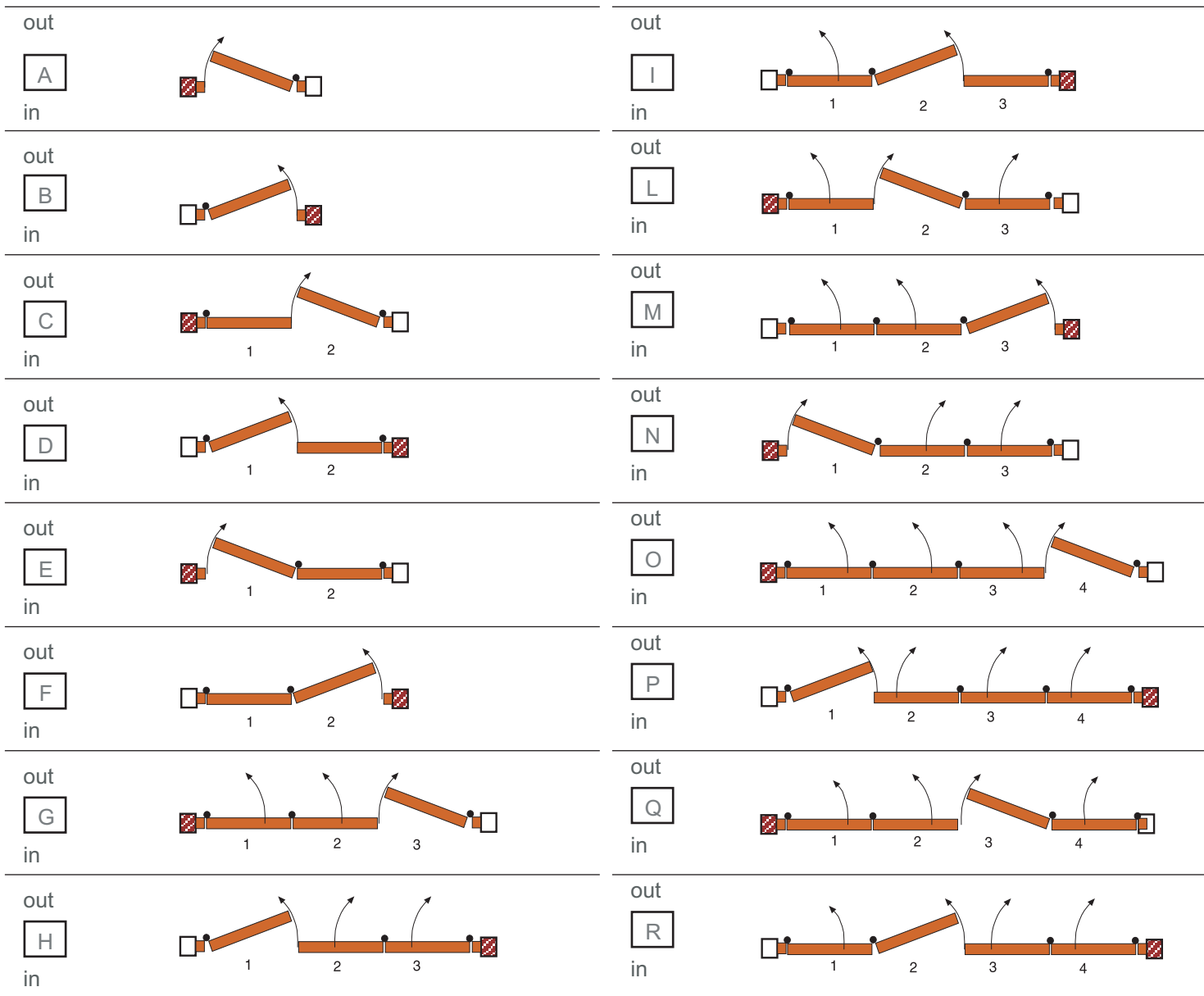

standard	by request
• Dark aluminium screening	• Fiberglass screening
• Frame profile "Z"	• Frame profile "L"
• cm 90 high cross profile	• Customized cross height
	• Asymmetrical shutters *
	<b>Optional</b>
	• Petscreen or aluminium screening
	• Superior fixed skylight

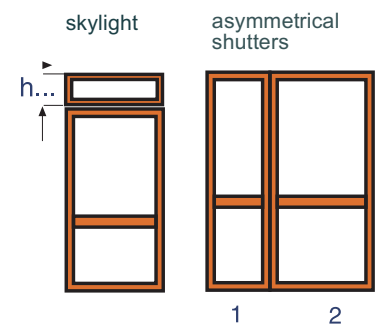

\* For the asymmetrical shutter, it's necessary to indicate the dimensions of each shutter.  
 (Ex: shutter n°1 width 500 - shutter n°2 width 800)

## STANDARD

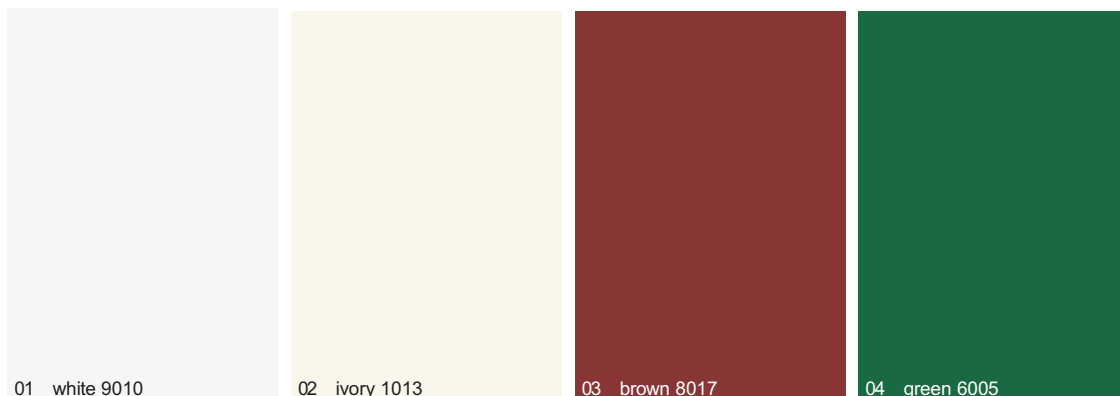

## MARBLE

any series + 10%

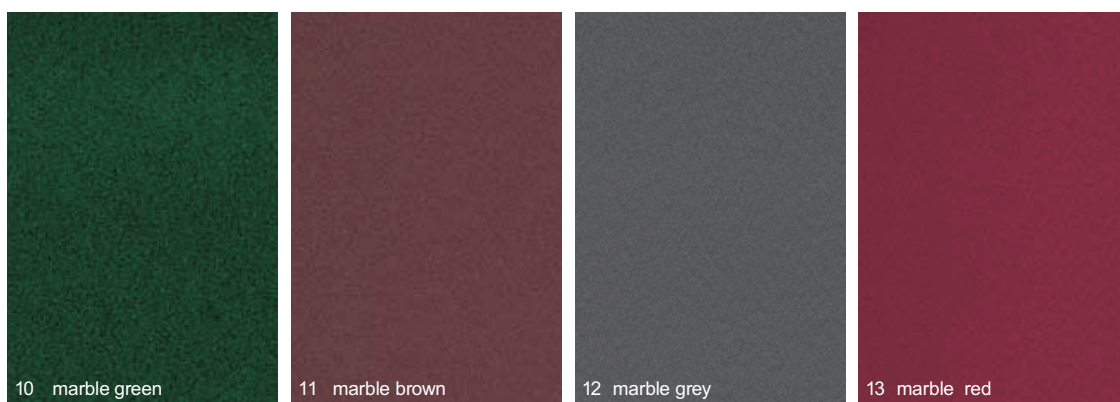

## SUBLIMATE

plissé + 30%

any series + 40%

america + 50%



## NATURALL

plissé + 30%

any series + 40%

america + 50%

